

Technical Data Sheet



Catalog No. K1XGF16-0.25

Characteristics	
Phase	1
KVA	0.25
Primary	120X240V
Secondary	16/32V
Conductor	Copper
Temp. Rise	115° C
Frequency	60 HZ
Taps	None
ESS	No
Insulation	180° C
Weathershield	N/A
Wall Bracket	Built-In
Weight(lbs)	15
Sound(dB)	40

Notes

All units are UL listed and are designed in accordance with applicable NEMA, ANSI and IEEE standards.

Transformers are dry-type AA, non-ventilated NEMA 3R enclosure.

Transformers are wall mounted. Wall mounting bracket is built into the enclosure.

Paint color is ANSI 61.

AMP Ratings

Line In (Load) @ 120V	2.1A
Line In (Load) @ 240V	1.0A
Load (Secondary) @ 16V	15.6A
Load (Secondary) @ 32V	7.8A

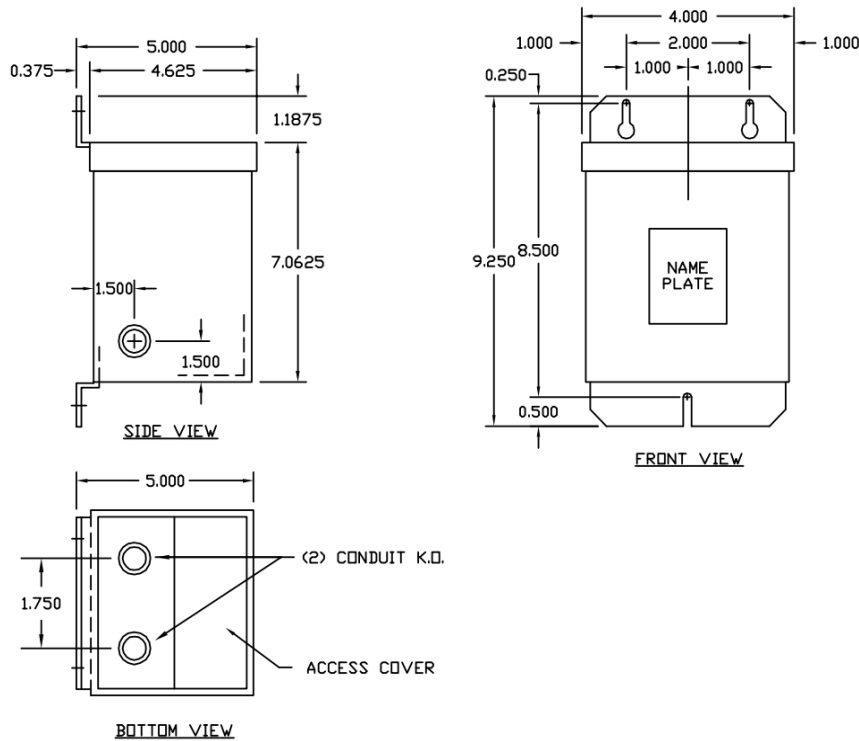
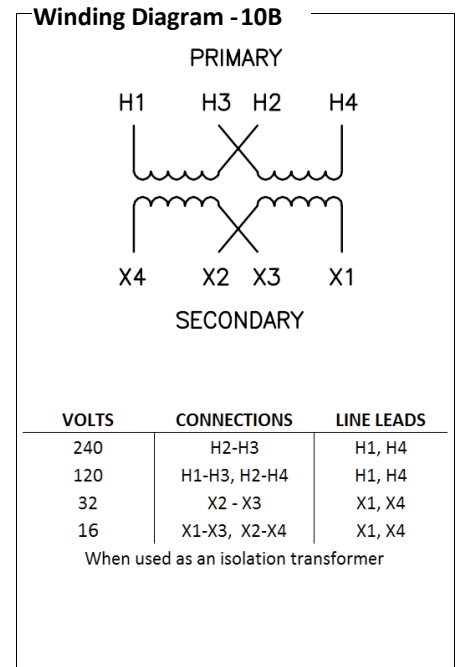

Outline No: 05A1462