

Technical Data Sheet



Catalog No. N48CF2D-3

Characteristics	
Phase	3
KVA	3
Primary	480Δ
Secondary	240Δ
Conductor	Copper
Temp. Rise	115° C
Frequency	60 HZ
Taps	-2@5%
ESS	Yes
Insulation	180° C
Weathershield	N/A
Wall Bracket	Built-In
Weight (lbs)	95
Sound(dB)	40

Notes

All units are UL listed and are designed in accordance with applicable NEMA, ANSI and IEEE standards.

Transformers are dry-type AA, non-ventilated NEMA 3R enclosure

Transformers are wall mounted. Wall mounting bracket is built into the enclosure.

Paint color is ANSI 61.

AMP Ratings

Line In (Primary) @ 480V	3.6A
Load (Secondary) @ 240V	7.2 A

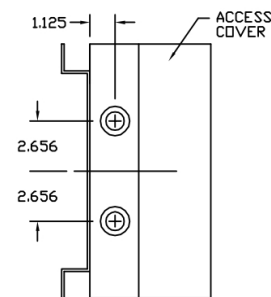
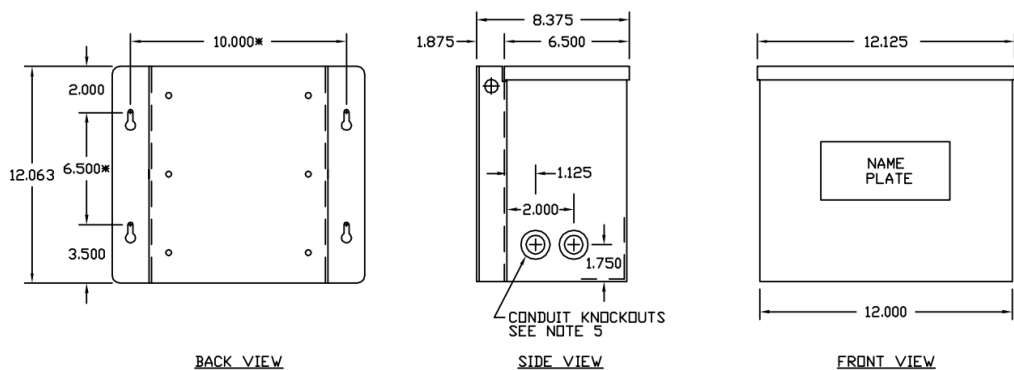
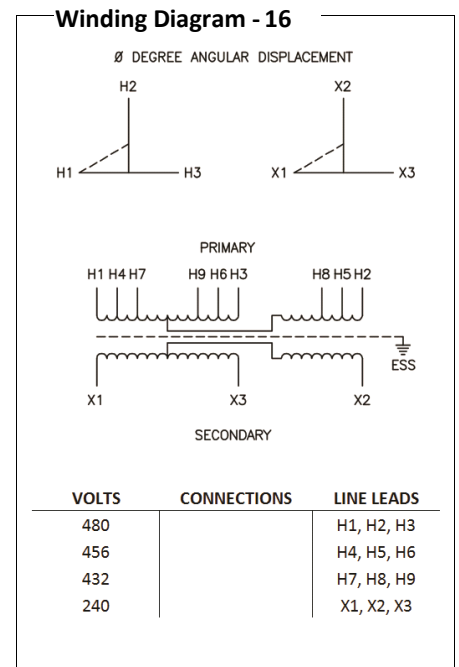

Outline No: 08A7633