

# Technical Data Sheet



## Catalog No. P2XGF21-0.75-N

Characteristics	
Phase	1
KVA	0.75
Primary	240x480v
Secondary	120/240v
Conductor	Copper
Temp. Rise	115° C
Frequency	60 HZ
Taps	None
ESS	No
Insulation	180° C
Weathershield	N/A
Wall Bracket	Built-In
Weight (lbs)	25
Sound (dB)	40

**Notes**

All units are UL listed and are designed in accordance with applicable NEMA, ANSI and IEEE standards.

Transformers are dry-type AA, non-ventilated NEMA 3R enclosure.

Transformers are wall mounted. Wall mounting bracket is built into the enclosure.

Paint color is ANSI 61.

**AMP Ratings**

<b>Line In (Load) @ 240V</b>	3.1A
<b>Line In (Load) @ 480v</b>	1.6A
<b>Load (Secondary) @ 120V</b>	6.3A
<b>Load (Secondary) @ 240V</b>	3.1A

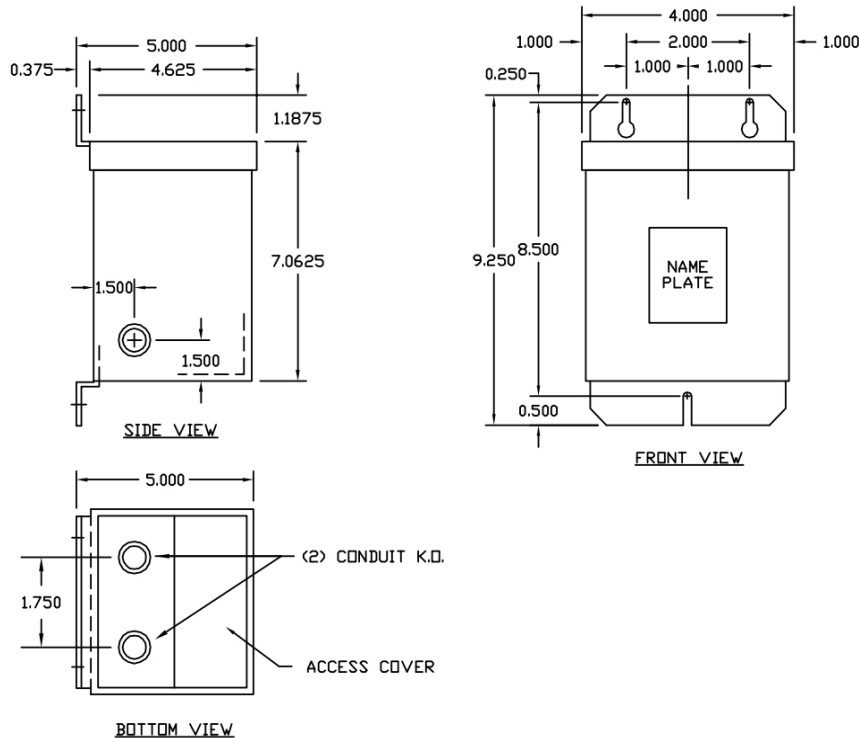
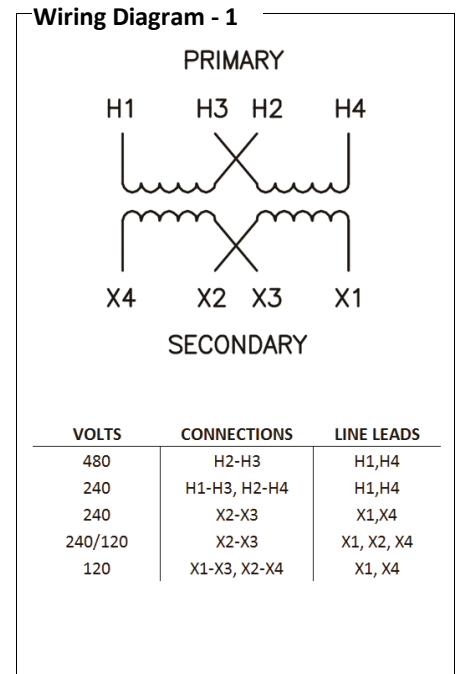

Outline No: 05A1462