

# Technical Data Sheet



## Catalog No. P60CF21-3

Characteristics	
Phase	1
KVA	3
Primary	600V
Secondary	120/240v
Conductor	Copper
Temp. Rise	115° C
Frequency	60 HZ
Taps	-2@5%
ESS	Yes
Insulation	180° C
Weathershield	N/A
Wall Bracket	Built-In
Weight(lbs)	60
Sound(dB)	40

Notes	
All units are UL listed and are designed in accordance with applicable NEMA, ANSI and IEEE standards.	
Transformers are dry-type AA, non-ventilated NEMA 3R enclosure.	
Transformers are wall mounted. Wall mounting bracket is built into the enclosure.	
Paint color is ANSI 61.	

AMP Ratings		
<b>Line In (Primary) @ 600V</b>		5.0A
<b>Load (Secondary) @ 120V</b>		25.0A
<b>Load (Secondary) @ 240v</b>		12.5A

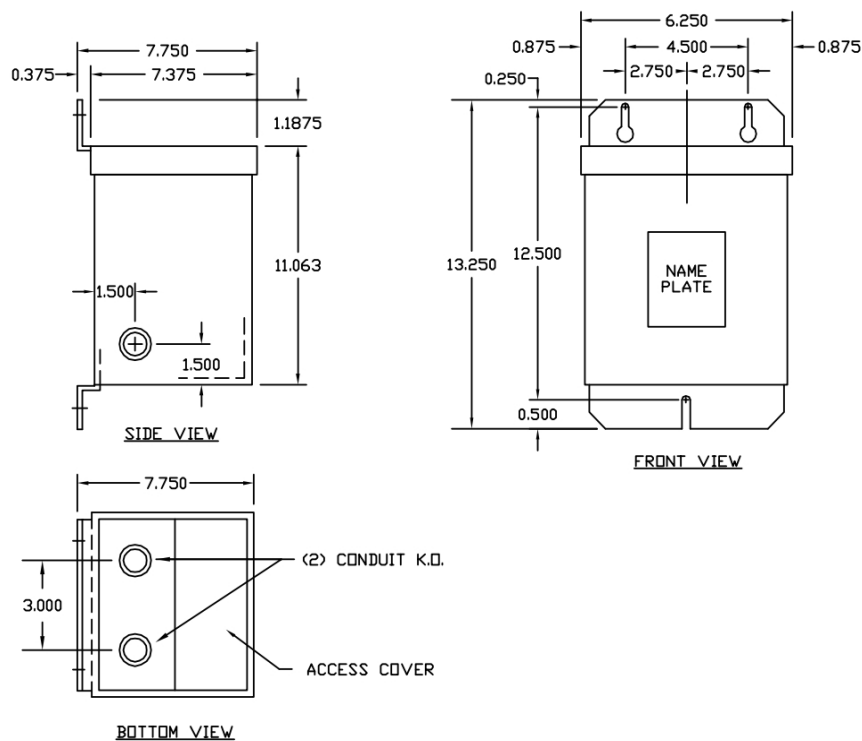
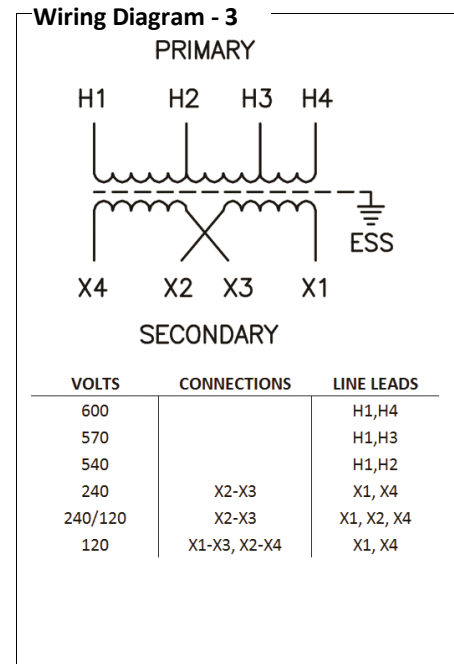

Outline No: 05A1464