

Typical Performance Technical Data Sheet



Catalog No S2XLH21-75

Characteristics	
Phase	1
KVA	75
Primary	240x480v
Secondary	120/240v
Conductor	Aluminum
Temp. Rise	150° C
Frequency	60 HZ
Taps	+2, -4 x 2.5%
ESS	No
Insulation	220° C
Weathershield	WS-5
Wall Bracket	WMB-4
Weight (lbs)	450
Sound (dB)	50

Typical Performance @ 170° C	
Regulation @ 100% PF	3.2%
Regulation @ 80% PF	4.7%
Impedance	4.8%
No Load Losses (W)	150
Full Load Losses (W)	2,440

AMP Ratings	
Line In (Load) @ 240V	313 A
Line In (Load) @ 480V	156 A
Load (Secondary) @ 120V	625 A
Load (Secondary) @ 240V	313 A

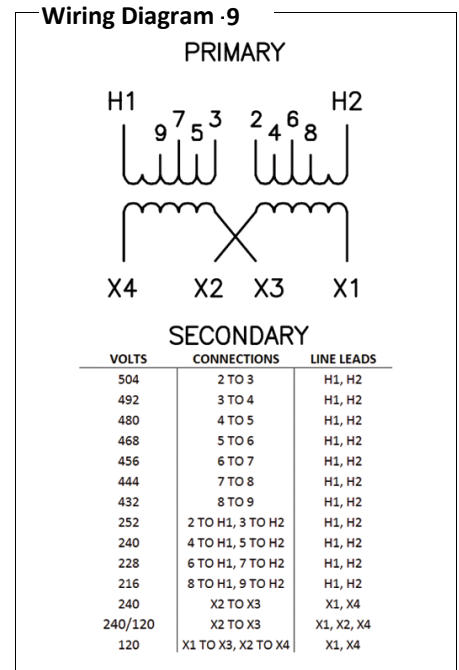

Notes

All units are UL listed and are designed in accordance with applicable NEMA, ANSI and IEEE standards.
 Transformers are dry-type AA, ventilated NEMA 2 enclosure.
 If a weathershield is indicated above this transformer can be converted to a NEMA 3R enclosure.
 Transformers are floor mounted. Wall mounting bracket kit if shown above is optional and is supplied as a separate accessory.
 Paint color is ANSI 61.

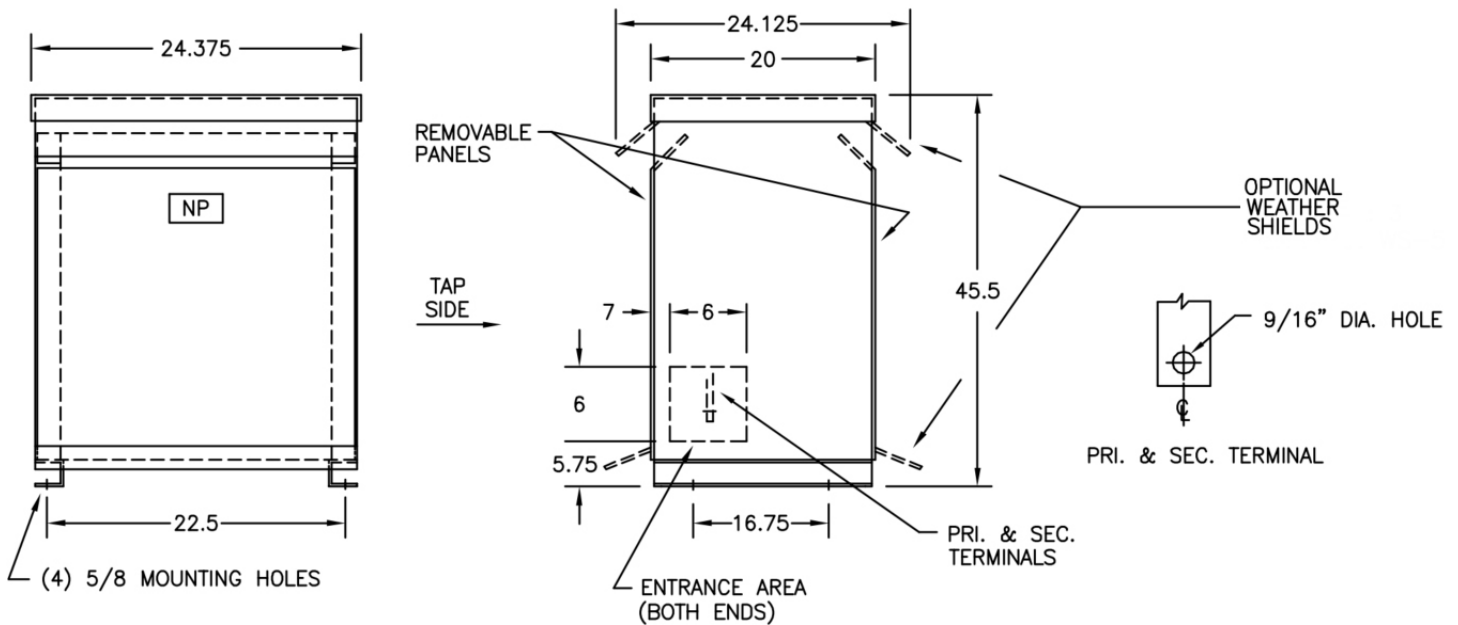

Outline No: 05A1255