

Typical Performance Technical Data Sheet



Catalog No. T24SB2Y-45

Characteristics	
Phase	3
KVA	45
Primary	240Δ
Secondary	208Y/120
Conductor	Aluminum
Temp. Rise	80° C
Frequency	60 HZ
Taps	+2, -4 x 2.5%
ESS	Yes
Insulation	220° C
Weathershield	WS-18
Wall Bracket	WMB-4
Weight (lbs)	685
Sound (dB)	45

Typical Performance @ 100° C	
Regulation @ 100% PF	1.4%
Regulation @ 80% PF	2.6%
Impedance	2.9%
No Load Losses (W)	143
Full Load Losses (W)	628

AMP Ratings	
Line In (Primary) @ 240V	108 A
Load (Secondary) @ 208V	125 A

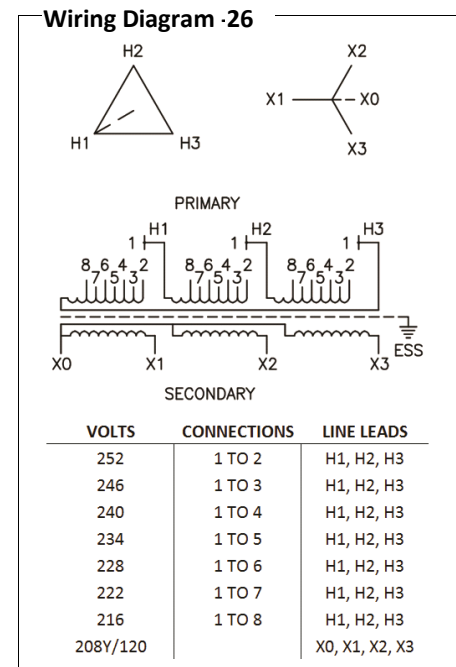

Notes

All units are UL listed and are designed in accordance with applicable NEMA, ANSI and IEEE standards. Transformers are dry-type AA, ventilated NEMA 2 enclosure. If a weathershield is indicated above this transformer can be converted to a NEMA 3R enclosure. Transformers are floor mounted. Wall mounting bracket kit if shown above is optional and is supplied as a separate accessory. Paint color is ANSI 61.

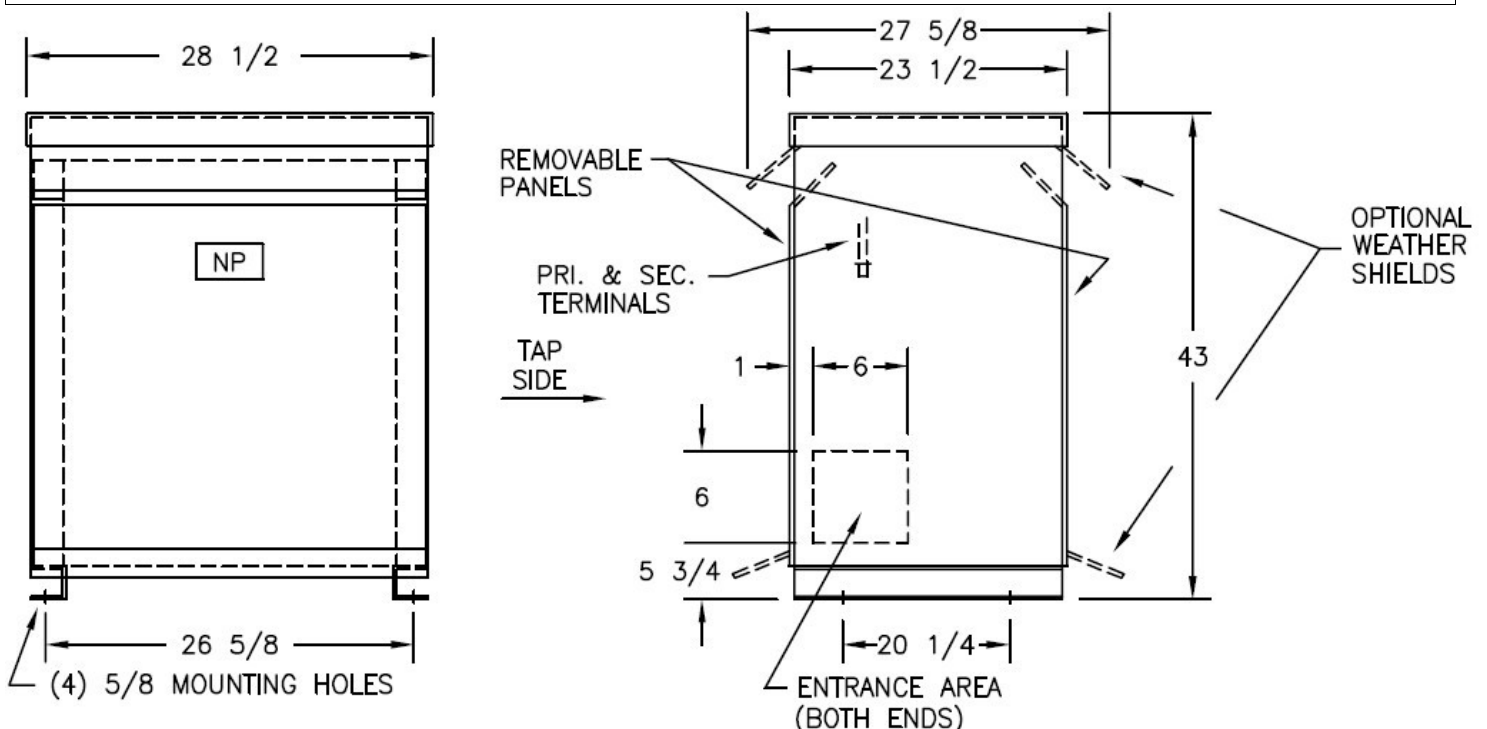

Outline No: 08A3224