

# Typical Performance Technical Data Sheet



## Catalog No T48CF2Y-225-K4

Characteristics	
Phase	3
KVA	225
Primary	480Δ
Secondary	208Y/120
Conductor	Copper
Temp. Rise	115° C
Frequency	60 HZ
Taps	+2, -4 x 2.5%
ESS	Yes
Insulation	220° C
Weathershield	38567741828
Wall Bracket	NONE
Weight (lbs)	38567741828
Sound (dB)	55

Typical Performance @ 135° C	
Regulation @ 100% PF	1.3%
Regulation @ 80% PF	3.4%
Impedance	4.1%
No Load Losses (W)	0
Full Load Losses (W)	2,753

AMP Ratings	
Line In (Primary) @ 480V	271 A
Load (Secondary) @ 208V	625 A

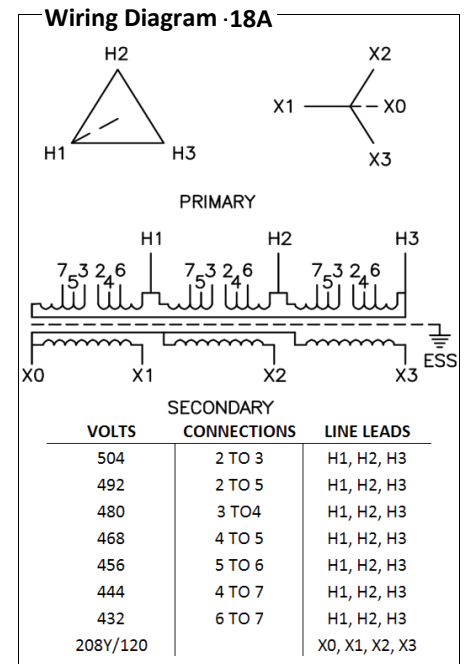

### Notes

All units are UL listed and are designed in accordance with applicable NEMA, ANSI and IEEE standards.  
 Transformers are dry-type AA, ventilated NEMA 2 enclosure.  
 If a weathershield is indicated above this transformer can be converted to a NEMA 3R enclosure.  
 Transformers are floor mounted. Wall mounting bracket kit if shown above is optional and is supplied as a separate accessory.  
 Paint color is ANSI 61.

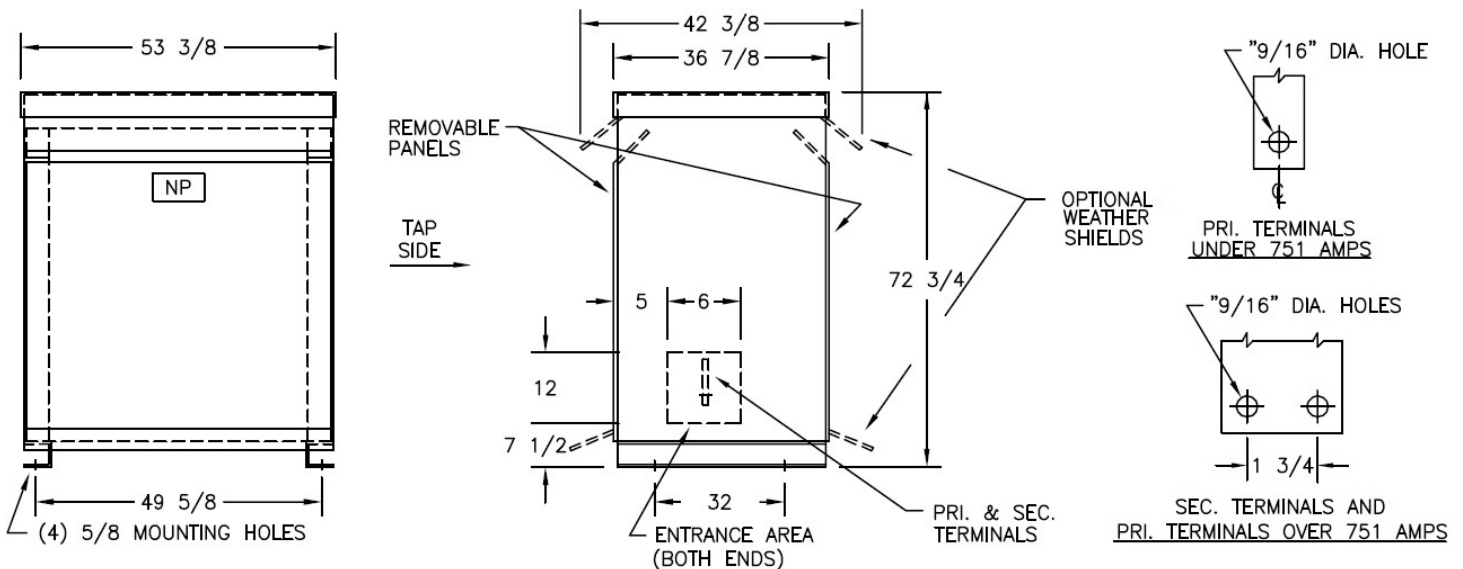

Outline No: 08A3228