

Typical Performance Technical Data Sheet



Catalog No. T48LH40-300

Characteristics	
Phase	3
KVA	300
Primary	480Δ
Secondary	400Y/230
Conductor	Aluminum
Temp. Rise	150° C
Frequency	60 HZ
Taps	+2, -4 x 2.5%
ESS	No
Insulation	220° C
Weathershield	WS-16
Wall Bracket	NONE
Weight (lbs)	2275
Sound (dB)	55

Typical Performance @ 170° C	
Regulation @ 100% PF	1.6%
Regulation @ 80% PF	4.3%
Impedance	5.3%
No Load Losses (W)	506
Full Load Losses (W)	4,924

AMP Ratings	
Line In (Primary) @ 480V	361 A
Load (Secondary) @ 400V	433 A

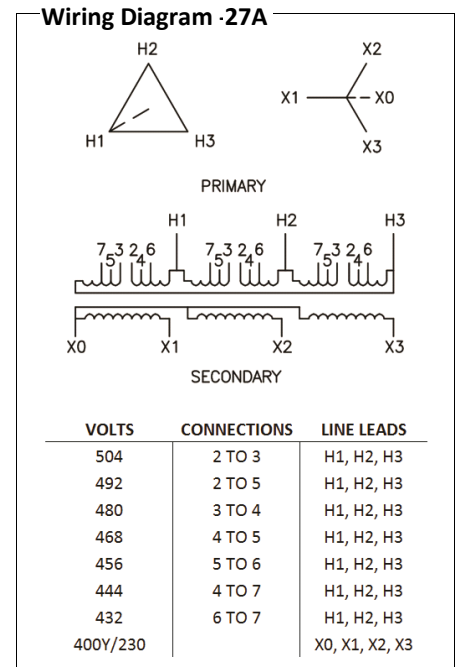

Notes

All units are UL listed and are designed in accordance with applicable NEMA, ANSI and IEEE standards. Transformers are dry-type AA, ventilated NEMA 2 enclosure. If a weathershield is indicated above this transformer can be converted to a NEMA 3R enclosure. Transformers are floor mounted. Wall mounting bracket kit if shown above is optional and is supplied as a separate accessory. Paint color is ANSI 61.

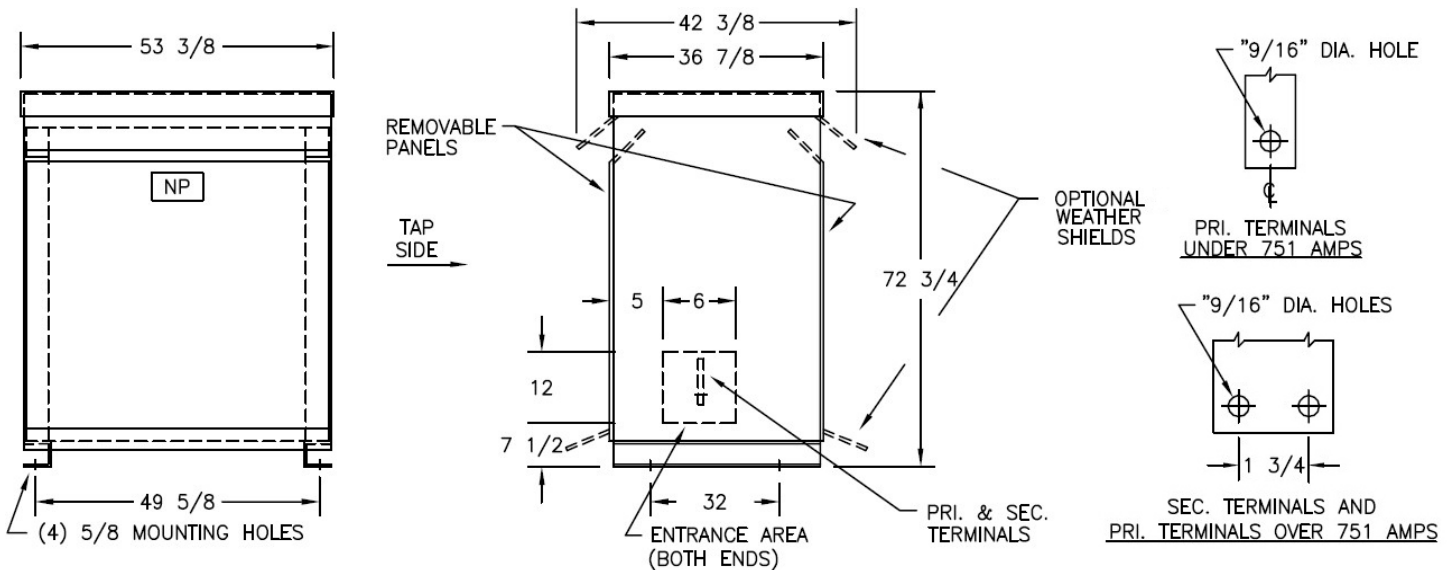

Outline No: 08A3228