

Typical Performance Technical Data Sheet



Catalog No T48SF2Y-300-K4

Characteristics	
Phase	3
KVA	300
Primary	480Δ
Secondary	208Y/120
Conductor	Aluminum
Temp. Rise	115° C
Frequency	60 HZ
Taps	+2, -4 x 2.5%
ESS	Yes
Insulation	220° C
Weathershield	WS-16
Wall Bracket	NONE
Weight (lbs)	3340
Sound (dB)	55

Typical Performance @ 135° C	
Regulation @ 100% PF	0.8%
Regulation @ 80% PF	2.2%
Impedance	2.7%
No Load Losses (W)	754
Full Load Losses (W)	2,381

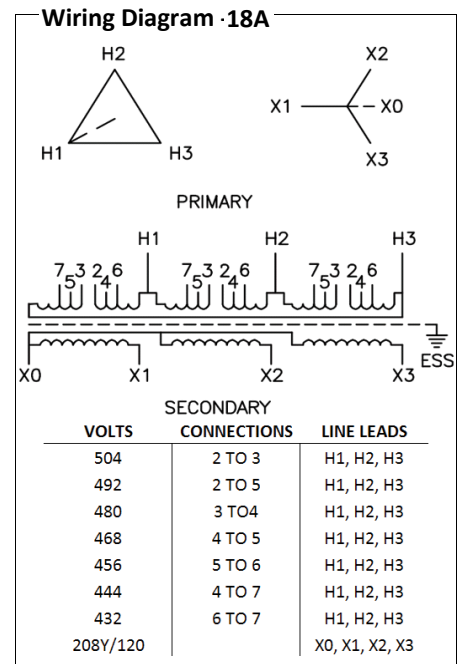

AMP Ratings

Line In (Primary) @ 480V	361 A
Load (Secondary) @ 208V	833 A

Notes

All units are UL listed and are designed in accordance with applicable NEMA, ANSI and IEEE standards.
 Transformers are dry-type AA, ventilated NEMA 2 enclosure.
 If a weathershield is indicated above this transformer can be converted to a NEMA 3R enclosure.
 Transformers are floor mounted. Wall mounting bracket kit if shown above is optional and is supplied as a separate accessory.
 Paint color is ANSI 61.

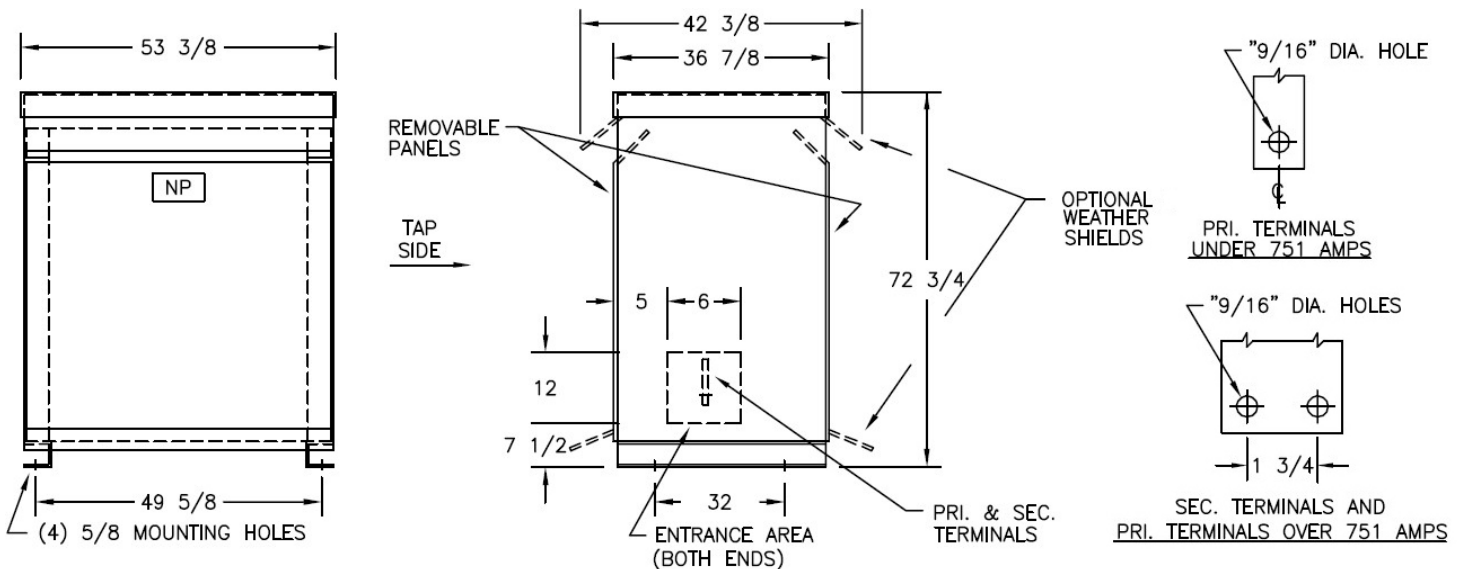

Outline No: 08A3228